

SEWOO

Aroot Co., Ltd.

28-6, Gajangsaneopdong-ro, Osan-si, Gyeonggi-do ,18103, Republic of Korea
TEL +82-31-8077-5000 / FAX +82-31-624-5310 / <http://www.miniprinter.com>

sewoo

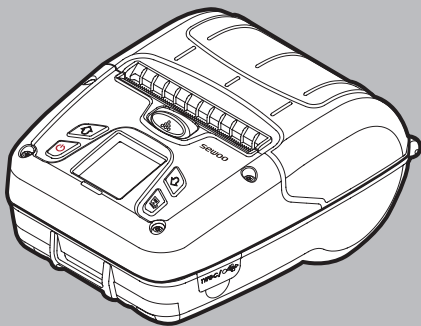

MODEL : LK-P300

MOBILE PRINTER(Wi-Fi & Bluetooth)

All specifications are subject to change without notice

Following information shall be included in the manual

Information to User;

Caution:

the user that changes or modifications not expressly approved by the Aroot Co., Ltd. responsible for compliance could void the user's authority to operate the equipment.

NOTE:

This equipment has been tested and found to comply with the limits for a Class B digital device, pursuant to part 15 of the FCC Rules. These limits are designed to provide reasonable protection against harmful interference in a residential installation. This equipment generates, uses and can radiate radio frequency energy and, if not installed and used in accordance with the instructions, may cause harmful interference to radio communications. However, there is no guarantee that interference will not occur in a particular installation.

If this equipment does cause harmful interference to radio or television reception, which can be determined by turning the equipment off and on, the user is encouraged to try to correct the interference by one or more of the following measures:

- Reorient or relocate the receiving antenna.
- Increase the separation between the equipment and receiver.
- Connect the equipment into an outlet on a circuit different from that to which the receiver is connected.
- Consult the dealer or an experienced radio/TV technician for help.

Responsible Party;

The responsible party for Supplier's Declaration of Conformity must be located within the United States, so you have to include following information in manual.

Company name : Aroot Co., Ltd. (Manager : Vic Barczyk)

Address : 19700 S. Vermont Ave. STE 200, Torrance, CA 90502 | USA

TEL / FAX No : (TEL) +310-561-8030 / (FAX) +82-31-459-8880

Homepage : <http://www.miniprinter.com>

Use of the Made for Apple badge means that an accessory has been designed to connect specifically to the Apple product(s) identified in the badge, and has been certified by the developer to meet Apple performance standards.

Apple is not responsible for the operation of this device or its compliance with safety and regulatory standards.

**This device complies with part 15 of the FCC Rules.
Operation is subject to the following two conditions.**

- 1) This device may not cause harmful interference, and
- 2) This device must accept any interference received, including interference that may cause undesired operation.



**Risk of explosion if battery is replaced by an incorrectly type.
Dispose of used battery according to the local disposal instructions.**

- replacement of a battery with an incorrect type that can defeat a safeguard (for example, in the case of same lithium battery types)
- disposal of a battery into fire or a hot oven, or mechanically crushing or cutting of a battery, that can result in an explosion;
- leaving a battery in an extremely high temperature surrounding environment that can result in an explosion or the leakage of flammable liquid or gas; and
- a battery subjected to extremely low air pressure that may result in an explosion or the leakage of flammable liquid or gas.



**Risque d'explosion si la batterie est remplacée par un type incorrect.
Jetez la batterie usée selon les instructions locales.**

- remplacement d'une batterie par un type incorrect qui peut faire échouer une sauvegarde (par exemple, dans le cas des mêmes types de batteries au lithium)
- la mise au rebut d'une batterie dans un feu ou un four chaud, ou l'écrasement ou la coupure mécanique d'une batterie, qui peut provoquer une explosion;
- laisser une batterie dans un environnement environnant à température extrêmement élevée pouvant entraîner une explosion ou une fuite de liquide ou de gaz inflammable; et
- une batterie soumise à une pression d'air extrêmement basse qui peut provoquer une explosion ou une fuite de liquide ou de gaz inflammable.



Disposal of Old Electrical & Electronic Equipment (Applicable in the European Union and other European countries with separate collection systems)

This symbol on the product or on its packaging indicates that this product shall not be treated as household waste. Instead it shall be handed over to the applicable collection point for the recycling of electrical and electronics equipment. For more detailed information about recycling of this product, please contact your local city office, your household waste disposal service or the shop where you purchased the product.

Safety Precautions

For better safety and reliability, adhere to the following precautionary measures.

Read and follow the instructions carefully before operation of the product.

Indication



Prohibition



Must follow



Do not disassemble



Unplug the power from the outlet



Grounding to prevent electric shock



Do not handle the product with wet hands



WARNING

Failure to follow these instructions could result in fire, electric shock, other injuries, or property damage.



Do not pull or touch the power plug with wet hands.

Potential risk of electric shock or fire



Do not bend the wire and do not allow the wire to be pinched or crushed by heavy objects.

Potential risk of electric shock or fire

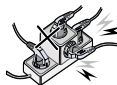

Do not overload an electrical outlet.

Potential risk of electric shock or fire

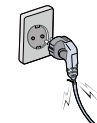

If a power plug is broken or a plug is cut or worn, do not use it.

Potential risk of electric shock or fire





WARNING

Failure to follow these instructions could result in fire, electric shock, other injuries, or property damage.



Do not unplug the power cable to turn off the product.

Turn off the power using the power button



Do not disassemble, repair or modify the product.

Potential risk of malfunction, electric shock, or fire. When the product needs to be repaired, please contact your reseller



CAUTION

Failure to follow these instructions could result in fire, electric shock, other injuries, or property damage.

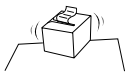

Do not install the product on an unstable or inclined surface.

May cause damage or injury

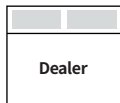

If the product needs to be repaired, please contact your reseller.

Potential risk of fire or unit malfunction



Keep product away from the water and other material.

Potential risk of fire or unit malfunction

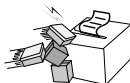

Avoid excessive shock or drops.

Potential risk of fire or property damage



Table of Contents

Product Overview

1. Unpacking	2
2. Product overview	3
3. Control Panel Usage	4

Set Up

4. Paper Installation	5
5. Power Save Function	6
5-1. Power Save Function	6
5-2. Recommended settings for Power Save Function	9

6. Battery	10
6-1. Battery Installation	10
6-2. Battery Removal	11
6-3. Battery Charging	12
6-4. Charging Cradle(optionl)	13
6-5. Set Cradle(optionl)	14

7. Belt Strap	15
---------------	----

8. Self Test	16
--------------	----

Peripheral Connection

9. Peripheral Connection	18
9-1. Bluetooth Connection	18
9-2. Wi-Fi Connection	19
9-3. USB Connection	19

Maintenance

10. Cleaning the Printer	20
---------------------------------	-----------

10-1. Print-Head Cleaning	20
---------------------------	----

10-2. Platen Roller Cleaning	21
------------------------------	----

11. JAM Error	22
----------------------	-----------

Specification

12. Black Mark	23
-----------------------	-----------

13. Gap	24
----------------	-----------

14. Printer Specification	25
----------------------------------	-----------

S/W Package

15. Utilities	27
----------------------	-----------

16. S/W	28
----------------	-----------

1. Unpacking

Standard



Printer



Battery

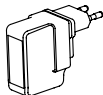

Charger

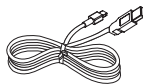

USB Cable

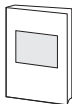

Quick Manual



CD (Manual)



Roll Paper



Belt Strap



Cleaning Pen

Optional

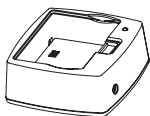

Charging Cradle

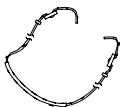
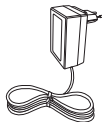

Shoulder Strap



Large Battery

2. Product overview

Front

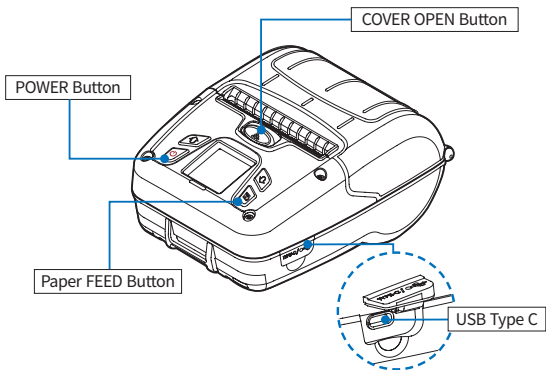



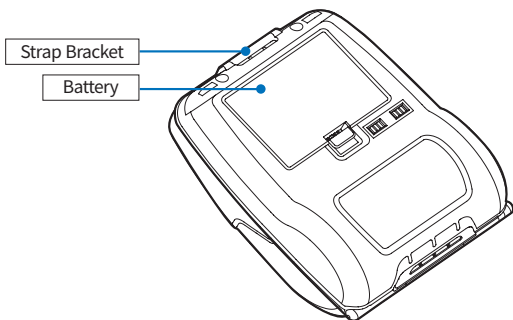

Rear

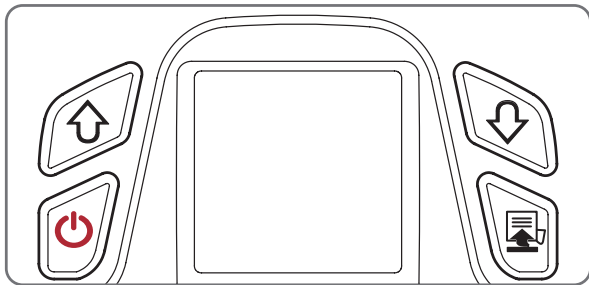

3. Control Panel Usage



Button	Name	Function
	Power Button	<ul style="list-style-type: none"> - This button is used to turn the printer on and off. - When the printer is off, press this button for a while, the printer will power on. - When you press this button approximately 3 seconds if the printer is powered on, the printer will power off.
	Menu exit Button	- When in the menu option screen, press this button to exit the menu option screen.
	Up Button	- This button is used to move the menu highlight up.
	Menu Enter Button	- This button is used to enter menu options.
	Down Button	- This button is used to move the menu highlight down.
	FEED Button	<ul style="list-style-type: none"> - This button can be used to manually feed the paper. - Additionally, this button is also used to initiate self-tests and Hexadecimal Dumping. ※ Refer to 11
	Menu Select Button	- When printer is entered menu option, Press this button to select the highlighted menu.

4. Paper Installation



CAUTION

Make sure to be careful of the HOT head

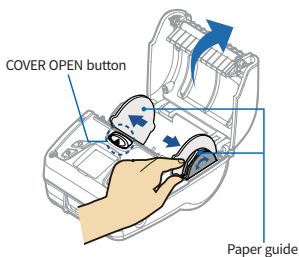

Press the COVER OPEN button up to open the Paper cover. You can set the width of paper guide by turning the knob with your finger.

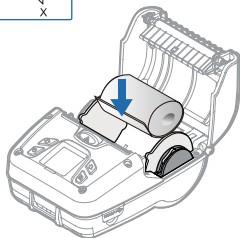
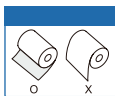

Place the paper roll as shown. Make sure the paper is placed in the right direction.



CAUTION

Please make sure you hear the closing sound of the upper cover.

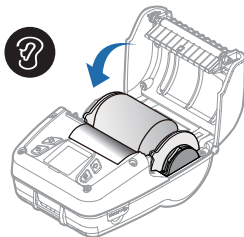

Pull a short length of paper out of the printer and close the cover.

1 2
3 4



CAUTION

If the cover is not shut down completely, the printer may not work properly.

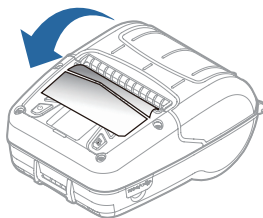

Please tear the paper down.

5. Power Save Function

5-1. Power Save Function

When the printer is idle for a period of time, the Power Save Function disables parts of printer's functionality in order to minimize the power consumption and extend the hours of battery use.

Power Save Mode

Sleep mode time : 0 Minute

Deep sleep mode time : 0 Minute

Power off mode time : 0 Minute



Power Save Time Setting

The time for the various Power Save modes can be set from 0 to 60 minutes(Power off mode time 0 to 120minutes). Once the printer has been idle for that set amount of time, the printer will automatically enter the mode and disable specific functions, based on the below table.

Setting mode	Function
Sleep mode time (Low power mode)	Once the time elapses, the printer goes into a low power mode where only the LCD screen is turned off, but keeps both the Bluetooth & Wi-Fi interfaces enabled.
Deep Sleep mode time (maximum energy saving mode)	Once the time elapses, the printer goes into the maximum energy saving mode, turning off both the LCD screen and the Bluetooth interface (If enabled). However, the WLAN interface, if enabled, will remain active and will receive data. ※ When in this mode and printing via Bluetooth, the printer will first need to be "woken" up by pressing any button on the control panel, before sending the print job to the printer.
Power off mode time	Once the time elapses, the printer turns itself off and can only be powered back on by pressing the Power ON button.

Setting up as a printer :

- For setting through the LCD screen, refer to the screen below.

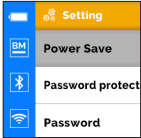
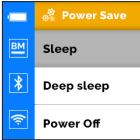
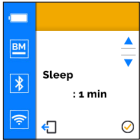
1. Setting Menu	2. Setting → Printer	3. Printer → Power Save
		
4. mode Select	5. mode time setting	
		

✓ NOTE

- Energy saving modes do not operate when the time is set to 0 minutes.
- When the power saving function is not activated, only the LCD Screen Saver operates.

Example 1: Enabling Only Sleep and Deep Sleep Modes

Power Save Mode

Sleep mode time : 1 Minute

Deep sleep mode time : 10 Minute

Power off mode time : 0 Minute

Power Save Time Setting

After being idle for 1 minute, the printer goes into Sleep (low power). If the printer remains idle for 10 minutes, the printer goes into the Deep Sleep (maximum energy saving) mode.

Example 2: Enabling all 3 Power Saving Modes

Power Save Mode

Sleep mode time : 1 Minute

Deep sleep mode time : 10 Minute

Power off mode time : 60 Minute

Power Save Time Setting

After being idle for 1 minute, the printer goes into Sleep (low power) mode. If the printer remains idle for 10 minutes, the printer goes into Deep Sleep (maximum energy saving) mode. If this state continues for 1 hour, then the printer turns itself off.

Example 3: Disabling All 3 Power Saving Modes

Power Save Mode

Sleep mode time : 0 Minute

Deep sleep mode time : 0 Minute

Power off mode time : 0 Minute

Power Save Time Setting

To disable the three power saving modes, set the values to '0' minutes. Only the LCD screen saver operates without any power saving function activated.

✓ NOTE

- If more than one mode is set, the function is activated in the following order : Sleep mode → Deep Sleep mode → Power Off mode.

5-2. Recommended settings for Power Save Function

IF using only Bluetooth :





- It is convenient to set the deep sleep waiting time to '0' to avoid entering deep sleep because automatic wakeup through data transmission to printer is not supported in deep sleep.
- Enable 'BT' from the LCD menu: Setting → Interface menu, or through the Configuration Tool's Interface Settings menu. It is recommended to turn off the WLAN function in order to prevent power consumption due to WLAN radio.

IF using only WLAN :

- Since the WLAN radio is enabled even when in Sleep and Deep Sleep mode, it is recommended to enable the Deep Sleep mode in order to minimize energy consumption during standby time.
- It is also recommended to turn off the BlueTooth function in order to prevent power consumption due to BlueTooth radio.
- Enable WLAN and disable BlueTooth from LCD menu: Setting → Interface menu, or through the Configuration Tool's Interface Settings menu.

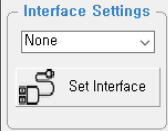
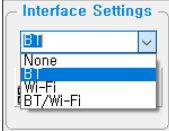
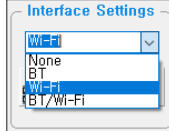
IF using only USB :

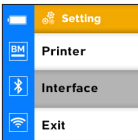
- It is recommended to set the Deep Sleep mode in order to minimize energy consumption during standby time.
- It is also recommended to turn off the BlueTooth and the WLAN functions in order to prevent power consumption due to BlueTooth and WLAN radios.
- Select 'None' from LCD menu setting → interface menu, or or through the Configuration Tool's Interface Settings menu.

Configuration Set - None	Configuration Set - BT	Configuration Set - WLAN
		
LCD menu Setting	Settings - Interface	Settings - None
		

6. Battery

6-1. Battery Installation



Please make sure you hear the click sound of the battery.

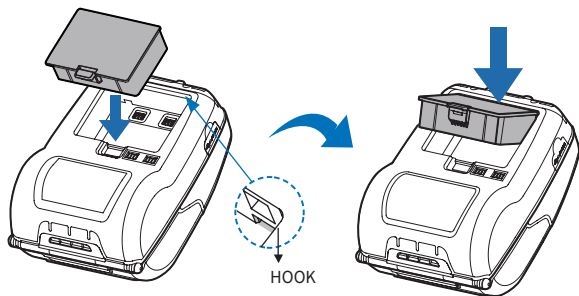

- 1 Align battery hook as shown in the picture.
- 2 Push the battery into the printer until it locks in place.

✓ NOTE

– As the battery is not charged at the time of your purchase, charge the battery prior to using the printer.

6-2. Battery Removal

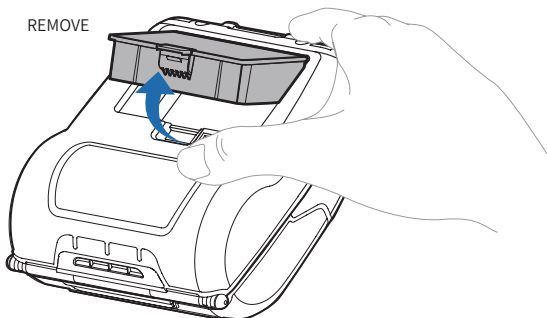

Remove the battery as shown.

- 1 Press up on the battery handle and lift it up.
- 2 Remove the battery.

6-3. Battery Charging

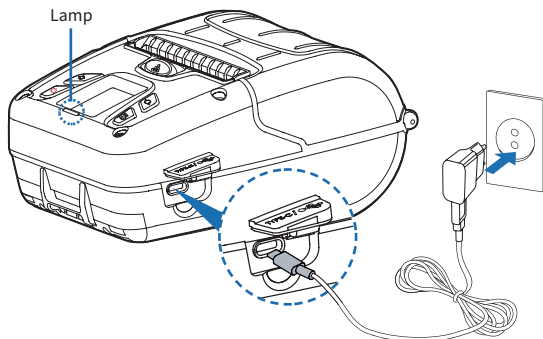

- 1 Make sure the printer is turned off.
- 2 After opening the cover, connect the to the printer.
- 3 Plug the power cord into the electrical outlet.

✓ NOTE

- 01 If the charger provided by the manufacturer is not used, the printer can be damaged, and the manufacturer is not liable for the consequential damage.
- 02 Before removing the battery, make sure that power is turned off.
- 03 The printer does not work when only connected to the charger.
- 04 While charging, do not turn on the power.
- 05 Do not operate the printer while charging the battery.

6-4. Charging Cradle Optional

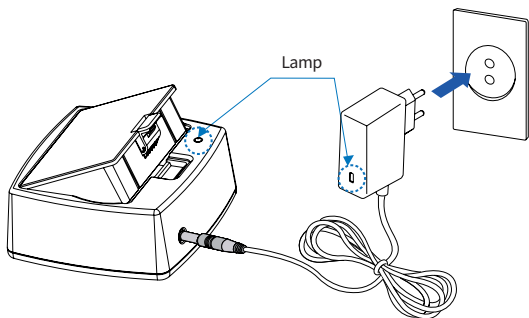

- 1 Insert the battery into the battery charger as shown above.
- 2 Connect the DC JACK to the electrical outlet.
- 3 Plug the power cord into the electrical outlet.
- 4 Once the charging is completed, remove the battery from the charger.

The charging status LED

Status	charging	charging complete	Not Battery
Charging Lamp	Red	Green	Green

✓ NOTE

- In the case the battery is not inserted properly, the red LED will blink. Remove and reinsert the battery.

6-5. Set Cradle

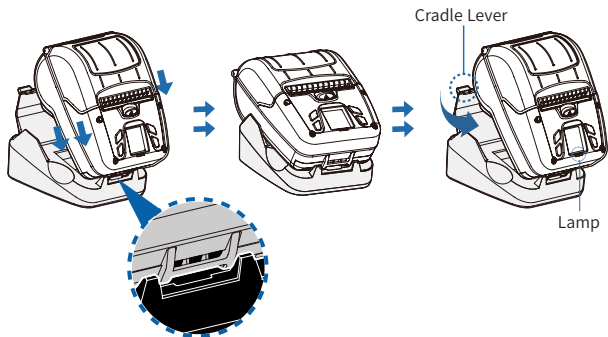

- 1 Place and slide the product from top to bottom of the Set Cradle as shown in the picture.
- 2 Connect the USB cable to the Set Cradle.
- 3 When charging is complete, push the Cradle Lever and take out the product to the top of the Set Cradle.

Battery Charging Status

Status	Charging	Charging complete	No Battery
LED	Red	Green	Blinking

7. Belt Strap



Prepare the belt strap.

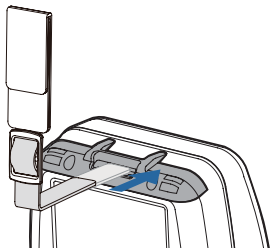

Put the strap into the strap bracket hole as shown.

1 2
3 4

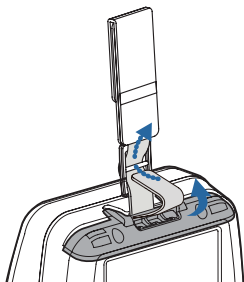

Turn the strap and printer over and put the strap into the hook as shown.

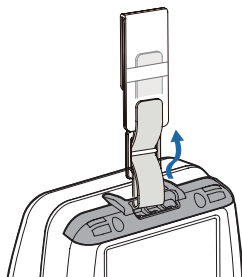

Adjust the strap length for the user's convenience.

8. Self Test

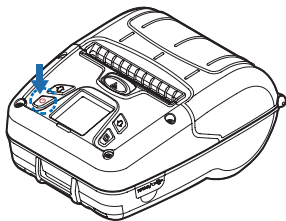

Turn off the power by pressing the power button for approximately 3 seconds.

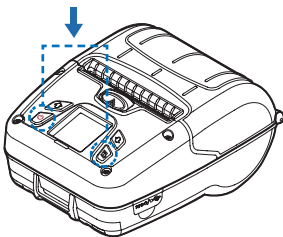

While you are holding the FEED button, press the power button.

1 2
3

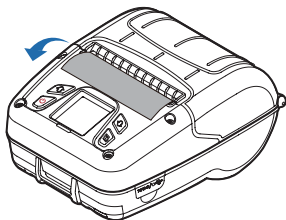

The self-test will print.

✓ NOTE

- 01 To enter hex dump mode, press the FEED button once more.
- 02 If the FEED button is not pressed, the self-test will automatically finish after 3 seconds.

Self-Test Printout Sample



SEWOO, LK-P300

Printer Configuration Info.
F/W Version: v2.74 STD
GAP(Adj) : 80(-10,270)
BM Lower Label Length : 320(127,240)
BM Lower Label Length : 0.0mm
BM Upper Label Length : 320(159,330)
BM Upper Label Length : 558,69mm
Battery : 8.0v [30 C]
Sleep Timeout : 1 min
Deep Sleep Timeout : 2 min
Power off Timeout : 0 min
H/W Version : v1.00

Emulation Configuration Info.
Emulation: ESC/POS
codepage 437
Print Density: Normal(0)
Print Speed: 5[IPS]
Liner less: Disabled
Password: Disabled

USB Interface
Version 2.0 Full speed
compliant
Product String: LK-P300

Bluetooth Interface
Version : v1.0
Device Name : SW_0A9B
Mode : SPP_JAP_MODE
Numeric comparison : Disabled
BT scan : Enabled
Auto connection : Enabled
BLE : Disabled
Address : 40:19:20:50:0a:9b



401920111725

WiFi Interface
SSID : LK_P300_P2P
MAC : 42:19:20:50:8a:9a
Operating Mode : SoftAP
IP : 192.168.100.1
SUBNET : 255.255.255.0
GATEWAY : 192.168.100.1
Host name : MobilePrinter
DHCP : Enabled



0000000000

Press FEED button to
enter HEX-DUMP mode.

Upon initial installation or for troubleshooting, you can run the diagnostic test to get information about:

- Firmware version, emulation, codepage, sensor settings, interface settings, etc.

If no issues are found with the diagnostic test, examine other devices and software.

The diagnostic test is working independently of devices and software.

※ Motor protection from being overheated

To prevent the motor from overheating, stop the printer for at least 30 seconds after continuously printing 1.5 meters.

9. Peripheral Connection

This product can communicate with other devices via Bluetooth or a communication cable.

9-1. Bluetooth Connection

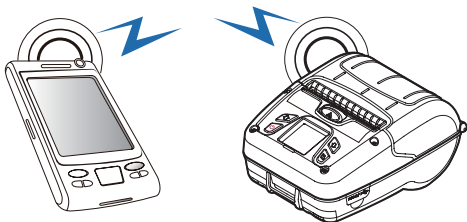

- 1 The Printer can be connected to devices equipped with Bluetooth communication capabilities (PDAs, PCs, etc.).
- 2 Use the Bluetooth connection function supported by your device to connect to the printer.
- 3 You can easily pair with Bluetooth using an NFC tag.

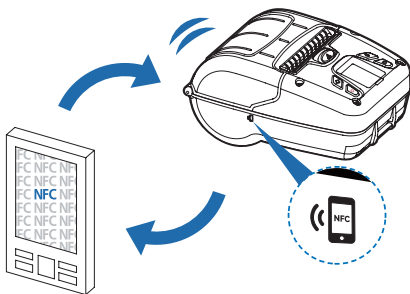

✓ NOTE

- This model supports numeric comparison function.
- Please refer to the configuration manual for details.

9-2. Wi-Fi Connection

- 1 The Printer can be connected to devices equipped with Wi-Fi communication capabilities (PDAs, PCs, etc.).
- 2 Use the Wi-Fi connection function supported by the device to connect to the printer.

✓ NOTE

– Please refer to the CONFIGURATION MANUAL for details.

9-3. USB Connection

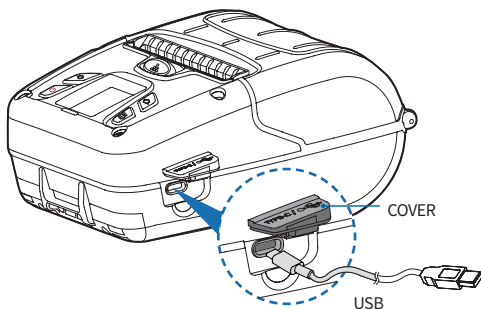

- 1 Flip over the connector cover and connect USB cable to the printer connector.
- 2 Connect the interface cable to the USB port of the device (PDA, PC, etc.).

✓ NOTE

– Only use cables included with the printer. (USB)

10. Cleaning the Printer

If the interior of the printer is dusty, printing quality can be reduced.

In this case, follow the instructions below to clean the printer.

✔ NOTE

- 01 Make sure to turn the printer power off prior to cleaning.
- 02 Regarding printhead cleaning, as the printhead gets very hot during printing, turn off the printer power and wait approximately 10 minutes before cleaning.
- 03 When cleaning the printhead, take care not to touch the heated portion of the printhead. The printhead can be damaged by static electricity.
- 04 Take care not to allow the printhead to become scratched and / or damaged in any way.
- 05 When using a linerless paper, clean regularly at least once after using 4~5 rolls or a week (Cleaning cycle may vary depending on usage.)

10-1. Print-Head Cleaning

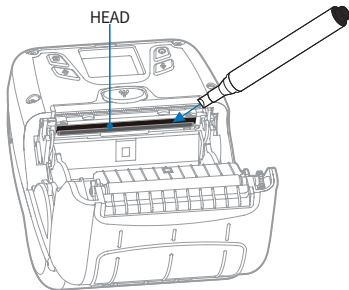

- 1 Use the cleaning pen to clean the head of the printer.
- 2 Once the cleaning is completed, wait a few minutes before inserting the paper roll into the printer.

10-2. Platen Roller Cleaning

- 1 Use a cleaning pen to clean the rollers.
- 2 Wipe the entire Roller by rotating it with your fingers.
- 3 When using a linerless paper, wipe the surrounding parts that touch the surface of the paper.

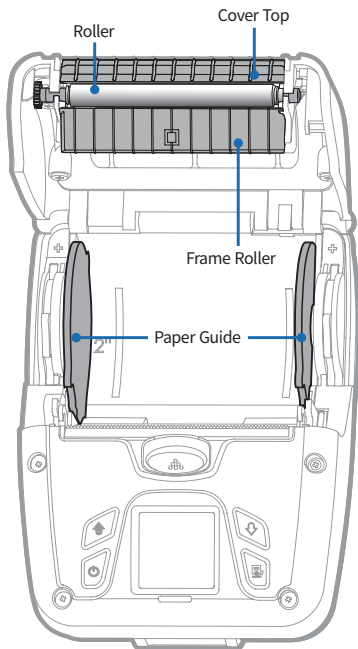

11. JAM Error

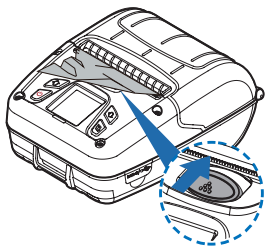

When you face with a paper jam error, please press the button up to open the **PRINTER COVER**.



CAUTION

Make sure to be careful of the **HOT** head.

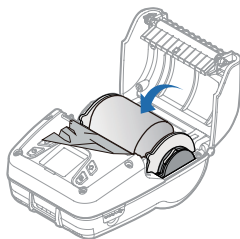

Please remove the paper.



NOTE

Please make sure you hear the closing sound of the upper cover.

1 2
3



NOTE

If the cover is not shut down completely, the printer may not work properly.

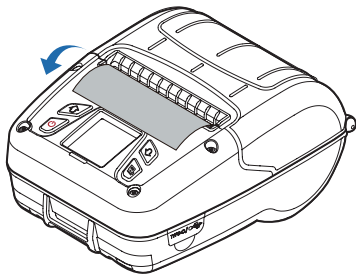

After removing, close the cover. The printer will work normally.

12. Black Mark

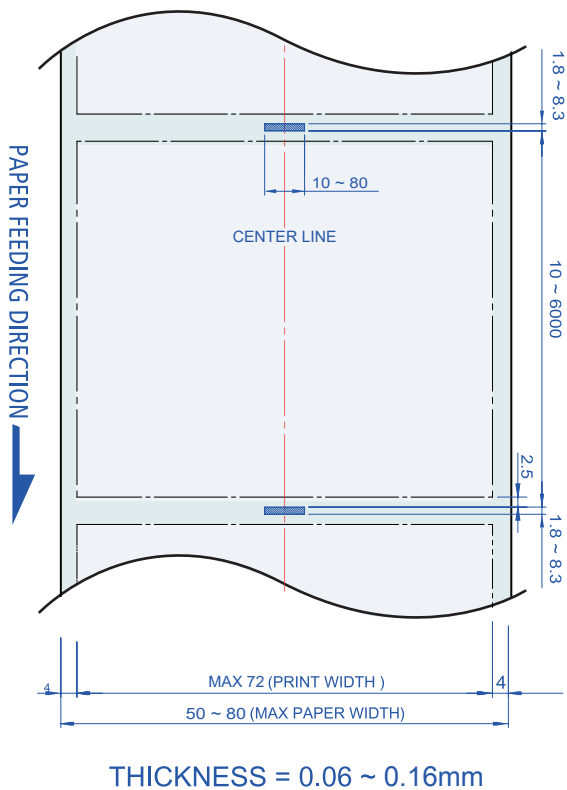

13. Gap

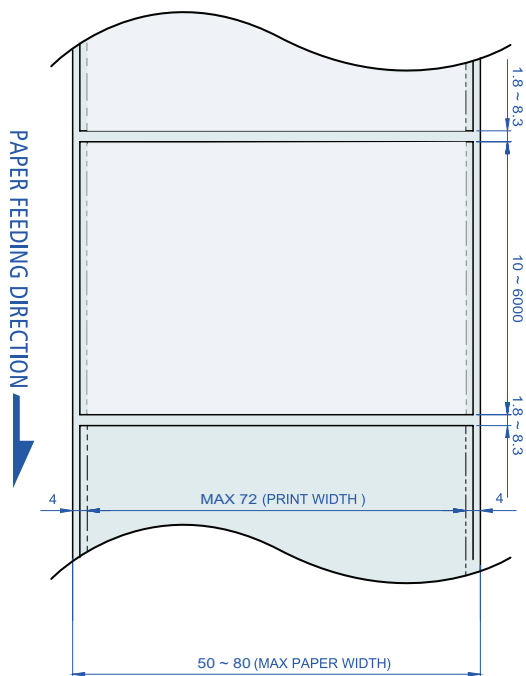

THICKNESS = 0.06 ~ 0.16mm

14. Printer Specification

Printing Method		Direct Thermal
Printing Speed		Max. 127mm/s
Resolution		203 DPI
Character		Font A(12×24), Font B(9×17), Asian Font(KOR,JPN,CHN-GB2312,CHN-Big5), Font0/1/2/4/5/6/7, Resident TTF, Downloadable TTF, FontA~H, FontGS, Resident TTF(Font0), Font 1~8
Barcode	ESC/POS	- 1D : EAN-8, EAN-13, Code39, ITF, UPC-A, UPC-E, Codabar, Code93, Code128 - 2D : QR, PDF417
	CPCL	- 1D : UPC-A(+2,+5), UPC-E(+2,+5), EAN13(+2,+5), EAN8(+2,+5), Code39 etc. (CPCL) - 2D : QR, PDF417, MicroPDF417, Maxicode, Datamatrix, Aztec, TLC39, RSS14
	ZPL	- 1D : Code11, ITF, Code39, Planet, EAN-8, UPC-E, Code93, Code128 etc. (ZPLII) - 2D : QR, PDF417, MicroPDF417, Maxicode, Datamatrix, Aztec, TLC39, RSS14
Emulation		ESC/POS, CPCL, ZPL Command compatible
Driver / SDK		Windows Driver(XP ~, Server2003 ~), Linux Driver, Mac Driver, OPOS Driver, JavaPOS Driver. Windows SDK, iOS SDK, Android(6.0 ~) SDK.
Sensor		Black mark, Paper end, Gap, Cover open

Paper	Type	Thermal Receipt / Black Mark (Lower, Upper) / Label / Linerless
	Roll Max Diameter	Max. 66.5m
	Roll Core	12.5 mm
Interface		USB, Wi-Fi(802.11a/b/g/n/ac), Bluetooth Smart ready combo(Bluetooth 4.2+BLE)
Battery Charger	Input	AC 100 ~ 240V, 50/60Hz
	Output	5V / 2A
Battery	Type	Li-ion
	Output	7.2 V, 2500 mAh, 5000 mAh(Optional)
	Charging time	2500 mAh : 3 Hrs (Power Off) 5000 mAh : 6.5 Hrs (Power Off)
Size(W x H x D)		158 x 118 x 80 mm
IP		IP54
Drop		2.1 m (set only)
Weight		0.72 kg (with Standard Battery)
Temperature (Non Condensing)	Operation	-20 ~ 55°C
	Storage	-30 ~ 65°C
Humidity (Non Condensing)	Operation	10 ~ 90%
	Storage	10 ~ 90%

15. Utilities

The following utilities and concerned manual can be found on the CD or homepage.

No.	Name	Description
1	Configuration Tool	This is a utility that allows you to set printers by interface. Detailed settings such as Wi-Fi, Ethernet, and COM ports can be configured.
2	Download Tool(F/W)	Printer F/W and Font Download are available, and BT, Wi-Fi module F/W Download is supported. – P22, 20II can download ICR F/W. – BT/Wi-Fi Download function is not supported for P400, P21, P25. – P400 supports SD Card Download function instead of Font Download.
3	NVUpload (ESC/POS)	With NVUpload running on Windows OS, you can upload and remove the bmp file as Logo in the printer's flash memory, and print test is possible.
4	Bitmap Font Download(CPCL)	It is a utility that allows you to change Windows Fonts stored on your PC into Bitmap Fonts for use on the printer.
5	LabelMaker(CPCL)	This program is for label form design and designed label printing.
6	Android Utility (Sewoo M_Utility) (ESC/POS)	It is a utility app that prints text, barcodes, images, etc. through Bluetooth and Wi-Fi communication, and able to printer settings.

16. S/W

We provides SDK, Driver, etc. as follows to respond to various S/W usage environments.

You can download this S/W from the homepage.

No	Name	Description
1	Windows Driver	This is an install program used to print a Mobile printer in Windows OS.
2	Linux Driver	This is the Cups Driver used to print a Mobile printer in the Linux environment.
3	OPOS Driver (ESC/POS)	This is a driver that controls Mobile printers using the OPOS standard. It can be used after initial setting(Mobile Printer&MSR) using the setting tool.
4	JavaPOS Driver (ESC/POS)	JavaPOS driver is an interface standard for POS software written in Java, and can be used in Mobile Printer when printing a receipt.
5	Mac Driver	This is the Cups Driver used to print a Mobile printer in the Mac OS environment.
6	Android Plugin (Sewoo Print Service Plugin) (ESC/POS)	This is a print service plug-in that allows you to print documents, images, and web pages without installing additional apps.
7	Windows SDK	This is library for communication and data output with Mobile printer in Windows OS.
8	Android SDK	This is library for communication and data output with Mobile printers in Android OS.
9	iOS SDK	This is library for communication and data output with Mobile printers in iOS.